

9

SAE flanges & flange adaptors

Flange Dimensions	Sec9:2
SAE Pipe Threaded Flanges	Sec9:3
SAE Socket Weld Flanges	Sec9:4
SAE Buttweld Flanges	Sec9:5
Blank Flanges	Sec9:5
SAE Split Flanges	Sec9:6
JIC-SAE Flange Adaptors	Sec9:7

All flange prices exclude bolts and o-rings

Flange Dimensions

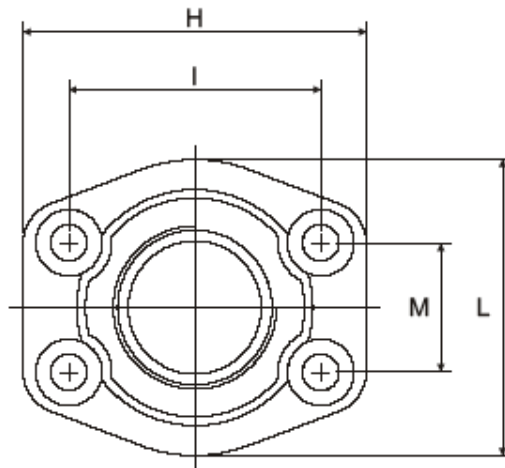

STANDARD PRESSURE SERIES 3000PSI						
Flange Size	H	L	I	M	Metric bolts	UNC bolts
Flange Size	Length	Width	Centres (Long)	Centres (Short)	Metric bolts	UNC bolts
1/2"	57	47	38	17.5	M8x25	5/16" X 1 1/4
3/4"	66	49	47.6	22.2	M10x30	3/8" X 1 1/4
1"	71	53	52.4	26.2	M10x35	3/8" X 1 1/2
1 1/4"	80	69	58.7	30.2	M10x35	7/16" X 1 1/2
1 1/2"	95	77	70	36.7	M12x40	1/2" X 1 1/2
2"	103	89	77.8	42.9	M12x40	1/2" X 1 1/2
2 1/2"	116	101	89	50.8	M12x40	1/2" X 1 1/2
3"	136	124	106.4	62	M16x45	5/8" X 1 3/4
3 1/2"	152	136	120.7	70	M16x50	5/8" X 2
4"	162	146	130	77.8	M16x50	5/8" X 2
5"	184	180	152.4	92	M16x50	5/8" X 2
HIGH PRESSURE SERIES 6000PSI						
Flange Size	H	L	I	M	Metric bolts	UNC bolts
Flange Size	Length	Width	Centres (Long)	Centres (Short)	Metric bolts	UNC bolts
1/2"	57	47	40	18.3	M8	5/16"
3/4"	71	53	50.8	23.8	M10	3/8"
1"	80	66	57.1	27.8	M12	7/16"
1 1/4"	94	77	66.7	31.6	M14	1/2"
1 1/2"	103	89	79.4	36.7	M16	5/8"
2"	135	123	96.8	44.4	M20	3/4"

SAE Pipe Thread Flanges (O-Ring) NPT Thread

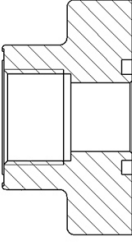
SAE PIPE THREAD FLANGES (O-RING) 3000 PSI SERIES	Part number	Description	Thread	Retail price R
	FLA AFS 80N	CODE 61 NPTF flange	1/2 NPT	
	FLA AFS 100N	CODE 61 NPTF flange	3/4 NPT	
	FLA AFS 102N	CODE 61 NPTF flange	1 NPT	
	FLA AFS 104N	CODE 61 NPTF flange	1 1/4 NPT	
	FLA AFS 106N	CODE 61 NPTF flange	1 1/2 NPT	
	FLA AFS 108N	CODE 61 NPTF flange	2 1/2 NPT	
	FLA AFS 110N	CODE 61 NPTF flange	2 NPT	
	FLA AFS 112N	CODE 61 NPTF flange	3 NPT	

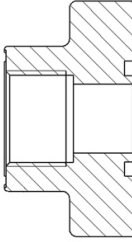
SAE PIPE THREAD FLANGES (O-RING) 6000 PSI SERIES	Part number	Description	Thread	Retail price R
	FLA AFS 401N	CODE 62 NPTF flange	1/2 NPT	
	FLA AFS 402N	CODE 62 NPTF flange	3/4 NPT	
	FLA AFS 403N	CODE 62 NPTF flange	1 NPT	
	FLA AFS 404N	CODE 62 NPTF flange	1 1/4 NPT	
	FLA AFS 405N	CODE 62 NPTF flange	1 1/2 NPT	
	FLA AFS 406N	CODE 62 NPTF flange	2 NPT	

SAE Pipe Thread Flanges (O-Ring) BSP Thread

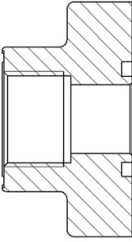
SAE PIPE THREAD FLANGES (O-RING) 3000 PSI SERIES	Part number	Description	Thread	Retail price R
	FLA AFS 80G	CODE 61 BSP flange	1/2 BSP	
	FLA AFS 100G	CODE 61 BSP flange	3/4 BSP	
	FLA AFS 102G	CODE 61 BSP flange	1 BSP	
	FLA AFS 104G	CODE 61 BSP flange	1 1/4 BSP	
	FLA AFS 106G	CODE 61 BSP flange	1 1/2 BSP	
	FLA AFS 108G	CODE 61 BSP flange	2 BSP	
	FLA AFS 110G	CODE 61 BSP flange	2 1/2 BSP	
	FLA AFS 112G	CODE 61 BSP flange	3 BSP	

SAE Pipe Thread Flanges (O-Ring) BSP Thread

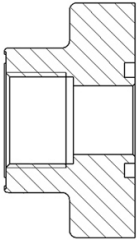
SAE PIPE THREAD FLANGES (O-RING) 6000 PSI SERIES	Part number	Description	Thread	Retail price R
AFS-G CODE 62 	FLA AFS 401G	CODE 62 BSP flange	1/2 BSP	
	FLA AFS 402G	CODE 62 BSP flange	3/4 BSP	
	FLA AFS 403G	CODE 62 BSP flange	1 BSP	
	FLA AFS 404G	CODE 62 BSP flange	1 1/4 BSP	
	FLA AFS 405G	CODE 62 BSP flange	1 1/2 BSP	
	FLA AFS 406G	CODE 62 BSP flange	2 BSP	

SAE Socket Weld Flanges (O-Ring)

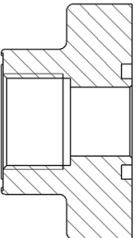
SAE SOCKET WELD FLANGES (O-RING) STANDARD PRESSURE 3000 PSI	Part number	Description	Retail price R
AFS-S CODE 61 	FLA AFS 80S	socket weld 1/2 SAE	
	FLA AFS 100S	socket weld 3/4 SAE	
	FLA AFS 102S	socket weld 1 3/4 SAE	
	FLA AFS 104S	socket weld 1 1/4 SAE	
	FLA AFS 106S	socket weld 1 1/2 SAE	
	FLA AFS 108S	socket weld 2 SAE	
	FLA AFS 110S	socket weld 2 1/2 SAE	
	FLA AFS 112S	socket weld 3 SAE	

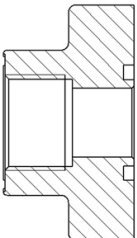
SAE SOCKET WELD FLANGES (O-RING) HIGH PRESSURE 6000 PSI	Part number	Description	Retail price R
AFS-S CODE 62 	FLA AFS 401S	socket weld 1/2 SAE	
	FLA AFS 402S	socket weld 3/4 SAE	
	FLA AFS 403S	socket weld 1 SAE	
	FLA AFS 404S	socket weld 1 1/4 SAE	
	FLA AFS 405S	socket weld 1 1/2 SAE	
	FLA AFS 406S	socket weld 2 SAE	

SAE Butt weld Flanges (O-Ring)

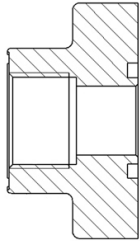
SAE PIPE FLANGES (O-RING) BUTTWELD SCHED 40 STANDARD PRESSURE 3000 PSI	Part number	Description	Retail price R
AFS-BT CODE 61 	FLA AFS 104BT FLA AFS 106BT FLA AFS 108BT	butt weld flange 1 1/4 SAE butt weld flange 1 1/2 SAE butt weld flange 2 SAE	

SAE Blank Flanges (O-Ring)

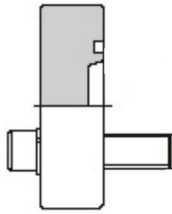
SAE BLANK FLANGES (O-RING) STANDARD PRESSURE 3000 PSI	Part number	Description	Retail price R
AFC - CODE 61 	FLA AFC 80S FLA AFC 100S FLA AFC 102S FLA AFC 104S FLA AFC 106S FLA AFC 108S FLA AFC 110S FLA AFC 112S	blank flange 1/2 SAE blank flange 3/4 SAE blank flange 1 SAE blank flange 1 1/4 SAE blank flange 1 1/2 SAE blank flange 2 SAE blank flange 2 1/2 SAE blank flange 3 SAE	

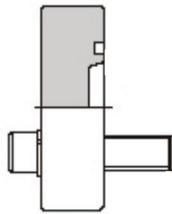
SAE BLANK FLANGES (O-RING) HIGH PRESSURE 6000 PSI	Part number	Description	Retail price R
AFC-S CODE 62 	FLA AFC 401S FLA AFC 402S FLA AFC 403S FLA AFC 404S FLA AFC 405S FLA AFC 406S	blank flange 1/2 SAE blank flange 3/4 SAE blank flange 1 SAE blank flange 1 1/4 SAE blank flange 1 1/2 SAE blank flange 2 SAE	

SAE Split Flanges

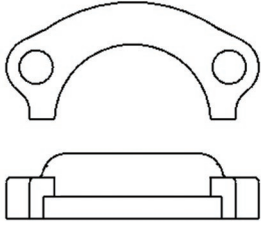
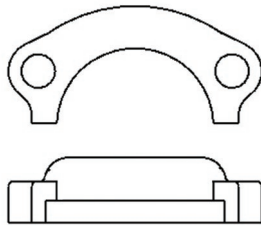
SAE SPLIT FLANGE 3000 PSI SERIES	Part number	SAE flange size	Retail price R
SF3 - CODE 61 	SF3 08	1/2	
	SF3 12	3/4	
	SF3 16	1	
	SF3 20	1 1/4	
	SF3 24	1 1/2	
	SF3 32	2	
SAE SPLIT FLANGE 6000 PSI SERIES	Part number	SAE flange size	Retail price R
SF6 - CODE 62 	SF6 08	1/2	
	SF6 12	3/4	
	SF6 16	1	
	SF6 20	1 1/4	
	SF6 24	1 1/2	
	SF6 32	2	

JIC-SAE Flange Adaptors 3000 PSI

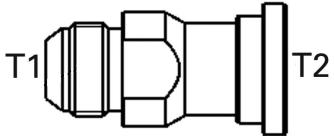
FLANGE ADAPTORS 3000 PSI	Part number	Thread (T1)	SAE flange size (T2)	Retail price R
FLS - CODE 61 	FLS 08J08FL	3/4 - 16	1/2	
	FLS 08J12FL	3/4 - 16	3/4	
	FLS 12J12FL	1 1/16 - 12	3/4	
	FLS 12J16FL	1 1/16 - 12	1	
	FLS 16J12FL	1 5/16 - 12	3/4	
	FLS 16J16FL	1 5/16 - 12	1	
	FLS 20J16FL	1 5/8 - 12	1	
	FLS 20J20FL	1 5/8 - 12	1 1/4	
	FLS 20J24FL	1 5/8 - 12	1 1/2	
	FLS 24J20FL	1 7/8 - 12	1 1/4	
	FLS 24J24FL	1 7/8 - 12	1 1/2	
	FLS 32J32FL	2 1/2 - 12	2	

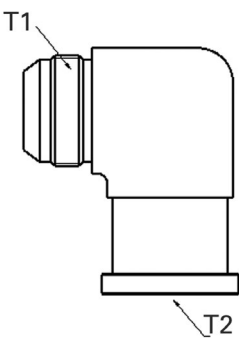
FLANGE ADAPTORS 3000 PSI	Part number	Thread (T1)	SAE flange size (T2)	Retail price R
FLE 90 - CODE 61 	FLE 08J08FL90	3/4 - 16	1/2	
	FLE 12J12FL90	1 1/16 - 12	3/4	
	FLE 12J16FL90	1 1/16 - 12	1	
	FLE 16J12FL90	1 5/16 - 12	3/4	
	FLE 16J16FL90	1 5/16 - 12	1	
	FLE 16J20FL90	1 5/16 - 12	1 1/4	
	FLE 20J16FL90	1 5/8 - 12	1	
	FLE 20J20FL90	1 5/8 - 12	1 1/4	
	FLE 24J20FL90	1 7/8 - 12	1 1/4	
	FLE 24J24FL90	1 7/8 - 12	1 1/2	
	FLE 32J32FL90	2 1/2 - 12	2	

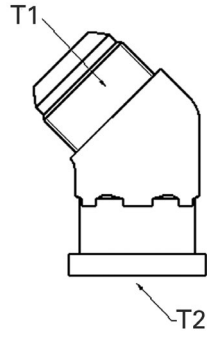
FLANGE ADAPTORS 3000 PSI	Part number	Thread (T1)	SAE flange size (T2)	Retail price R
FLE 45 - CODE 61 	FLE 08J08FL45	3/4 - 16	1/2	
	FLE 12J12FL45	1 1/16 - 12	3/4	
	FLE 16J12FL45	1 5/16 - 12	3/4	
	FLE 16J16FL45	1 5/16 - 12	1	
	FLE 20J16FL45	1 5/8 - 12	1	
	FLE 20J20FL45	1 5/8 - 12	1 1/4	
	FLE 24J20FL45	1 7/8 - 12	1 1/4	
	FLE 24J24FL45	1 7/8 - 12	1 1/2	
	FLE 32J32FL45	2 1/2 - 12	2	

SAE Flange Adaptors 6000 PSI

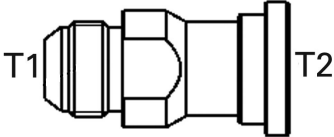
FLANGE ADAPTORS 6000 PSI	Part number	Thread (T1)	SAE flange size (T2)	Retail price R
FLS - CODE 62 	FLS6 08J08FL	3/4 - 16	1/2	
	FLS6 12J12FL	1 1/16 - 12	3/4	
	FLS6 16J12FL	1 5/16 - 12	1	
	FLS6 16J16FL	1 5/16 - 12	1	
	FLS6 20J20FL	1 5/8 - 12	1 1/4	
	FLS6 24J20FL	1 7/8 - 12	1 1/4	
	FLS6 24J24FL	1 7/8 - 12	1 1/2	
	FLS6 32J32FL	2 1/2 - 12	2	

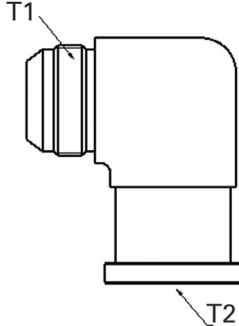
FLANGE ADAPTORS 6000 PSI	Part number	Thread (T1)	SAE flange size (T2)	Retail price R
FLE 90 - CODE 62 	FLE6 08J08FL90	3/4 - 16	1/2	
	FLE6 12J12FL90	1 1/16 - 12	3/4	
	FLE6 16J12FL90	1 5/16 - 12	1	
	FLE6 16J16FL90	1 5/16 - 12	1	
	FLE6 20J20FL90	1 5/8 - 12	1 1/4	
	FLE6 24J20FL90	1 7/8 - 12	1 1/4	
	FLE6 24J24FL90	1 7/8 - 12	1 1/2	
	FLE6 32J32FL90	2 1/2 - 12	2	

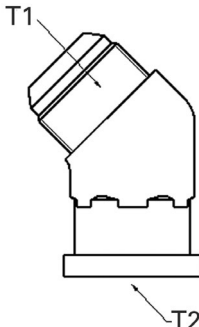
FLANGE ADAPTORS 6000 PSI	Part number	Thread (T1)	SAE flange size (T2)	Retail price R
FLE 45 - CODE 62 	FLE6 08J08FL45	3/4 - 16	1/2	
	FLE6 12J12FL45	1 1/16 - 12	3/4	
	FLE6 16J12FL45	1 5/16 - 12	1	
	FLE6 16J16FL45	1 5/16 - 12	1	
	FLE6 20J20FL45	1 5/8 - 12	1 1/4	
	FLE6 24J20FL45	1 7/8 - 12	1 1/4	
	FLE6 24J24FL45	1 7/8 - 12	1 1/2	
	FLE6 32J32FL45	2 1/2 - 12	2	